

# STABILIZER BARS

## TRP-4000

### MAN FORTUNA STABILIZATOR

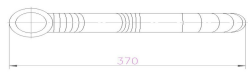
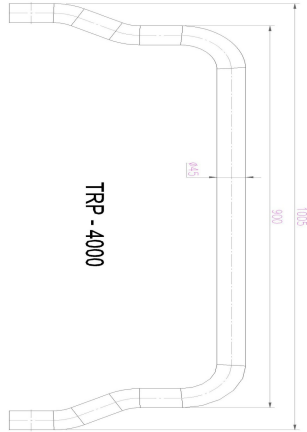

OEM REFERENCES		CROSS REFERENCES	
MAN	81437150100		
MAN	81437156064		

## TRP-4001

### MITSUBISHI PRENSES STABILIZATOR

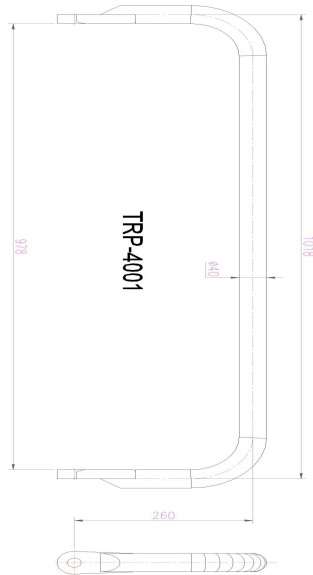
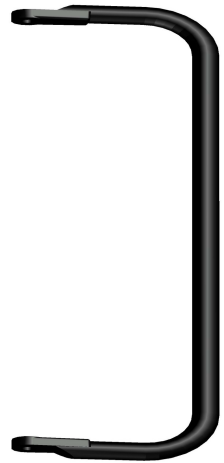

OEM REFERENCES		CROSS REFERENCES	

## TRP-4002

### TEMSA SAFİR FRONT STABILIZATOR

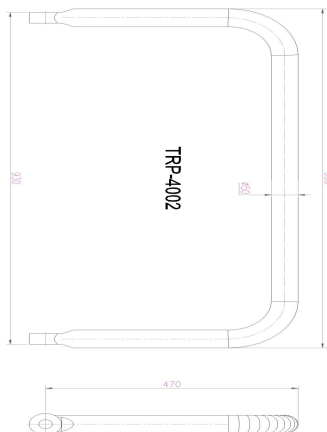

OEM REFERENCES		CROSS REFERENCES	
MITSUBISHI	MC371043		

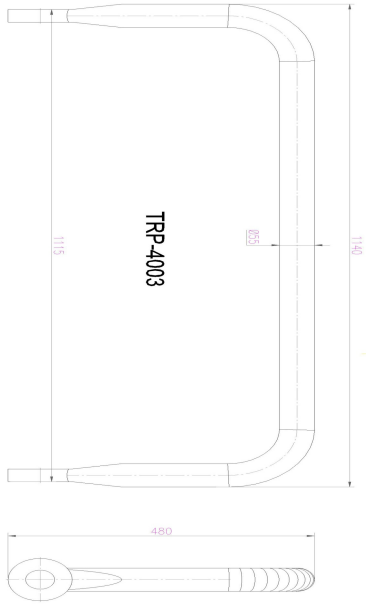

**TRP-4003**    **TEMSA SAFİR REAR STABILIZATOR**

OEM REFERENCES		CROSS REFERENCES	
MITSUBISHI	MC286631		

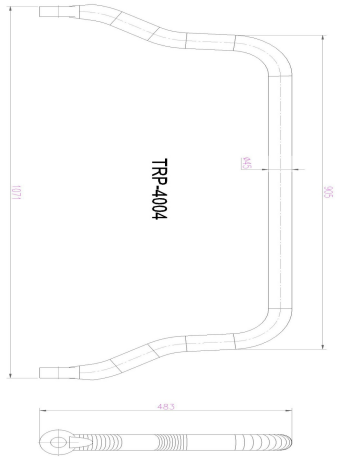
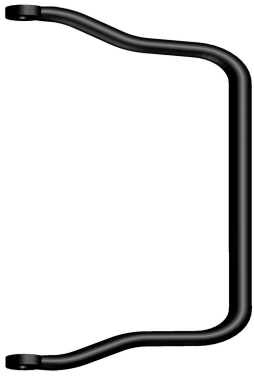

**TRP-4004**    **TEMSA SAFİR STABILIZATOR (NEW MODEL)**

OEM REFERENCES		CROSS REFERENCES	
TEMSA	HD260201Y		



**TRP-4005**    **MERCEDES 3032 TRUCK REAR STABILIZATOR**

OEM REFERENCES		CROSS REFERENCES	

## TRP-4006

## MERCEDES 3032 TRUCK FRONT STABILIZATOR

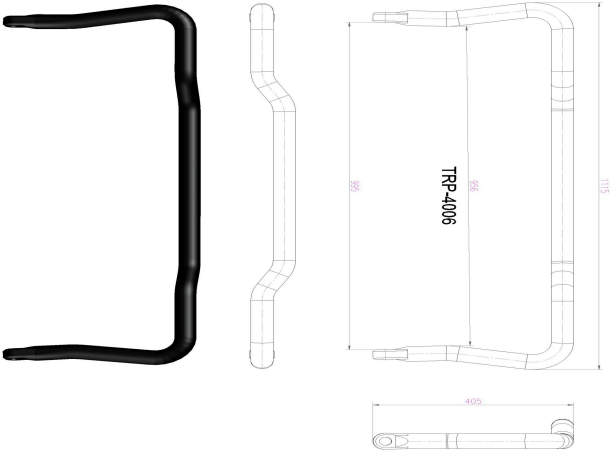

OEM REFERENCES		CROSS REFERENCES	
MERCEDES	6523230765		

## TRP-4007

## MERCEDES CONNECTO STABILIZATOR

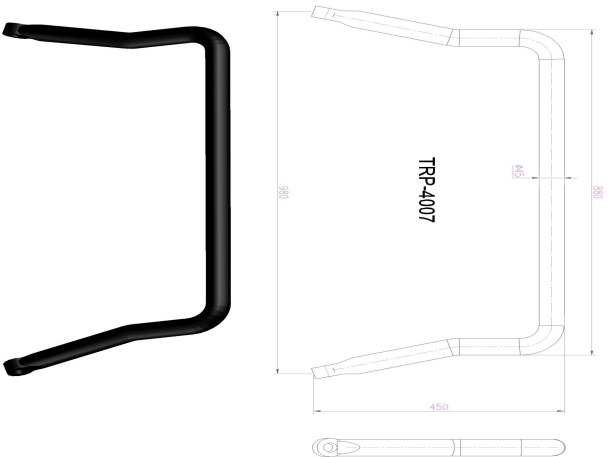

OEM REFERENCES		CROSS REFERENCES	
MERCEDES	6283260265		

## TRP-4008

## GÜLERYÜZ-COBRA FRONT STABILIZATOR

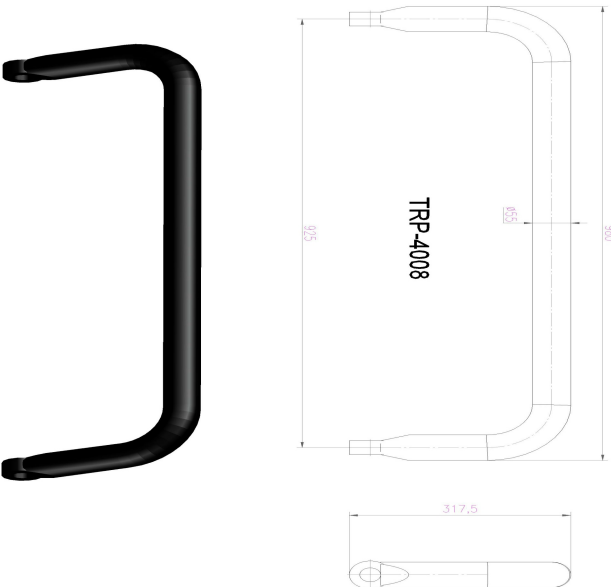

OEM REFERENCES		CROSS REFERENCES	

**TRP-4009 MERCEDES V8 FRONT STABILIZATOR**

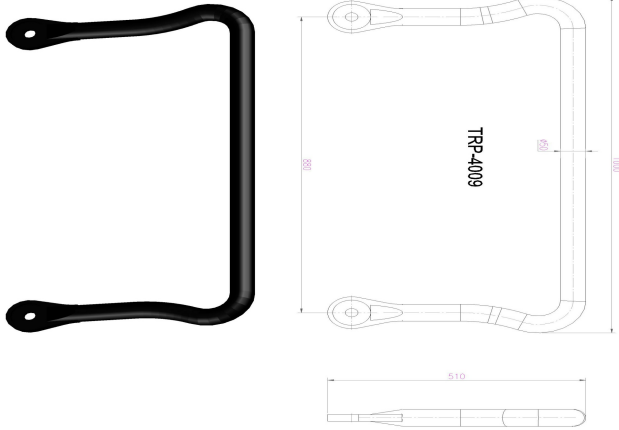

OEM REFERENCES		CROSS REFERENCES	
MERCEDES	3013230065		

**TRP-4010 MAN TEZELLER STABILIZATOR**

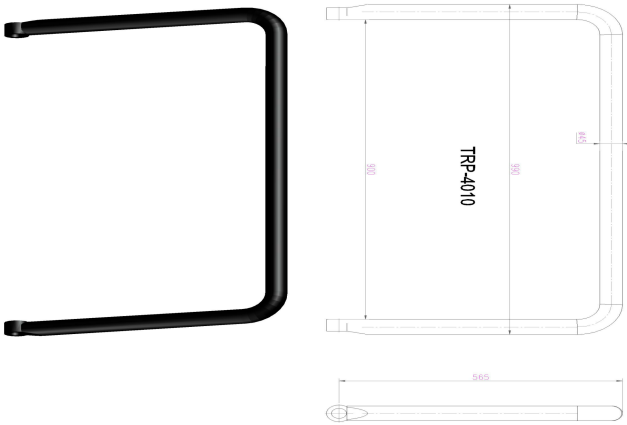

OEM REFERENCES		CROSS REFERENCES	

**TRP-4011 MERCEDES 0403 FRONT STABILIZATOR**

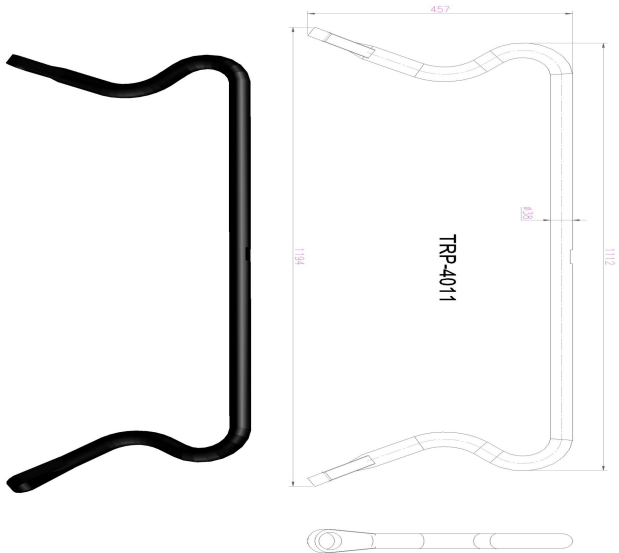

OEM REFERENCES		CROSS REFERENCES	
MERCEDES	3563200311		

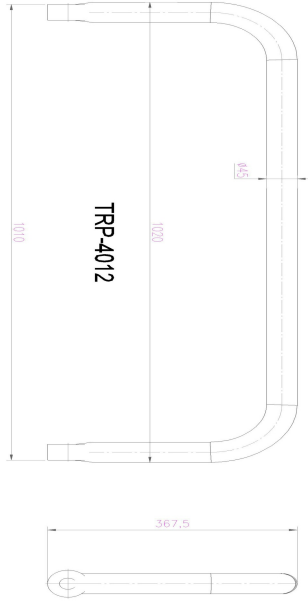

**TRP-4012** NEOPLAN STABILIZER

OEM REFERENCES		CROSS REFERENCES	
NEOPLAN	11015917		

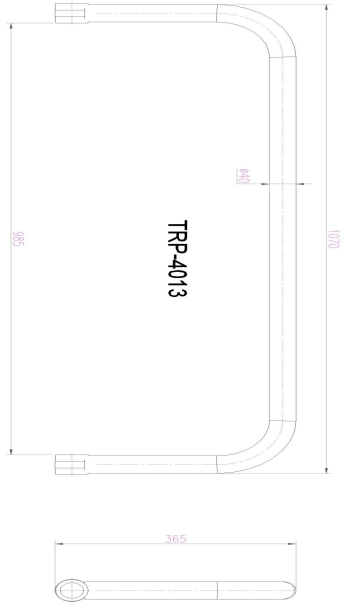
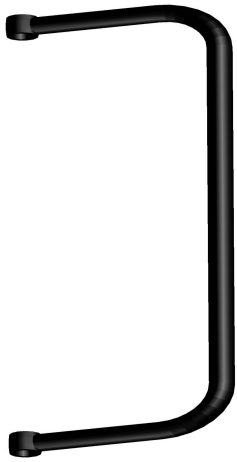

**TRP-4013** BMC PROBUS STABILIZER

OEM REFERENCES		CROSS REFERENCES	
BMC	7B84692		
BMC	7B808946		

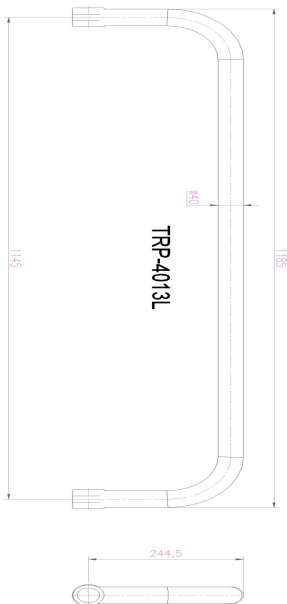

**TRP-4013-L**

OEM REFERENCES		CROSS REFERENCES	

**TRP-4014**

**MERCEDES TRAVEGO STABILIZATOR**

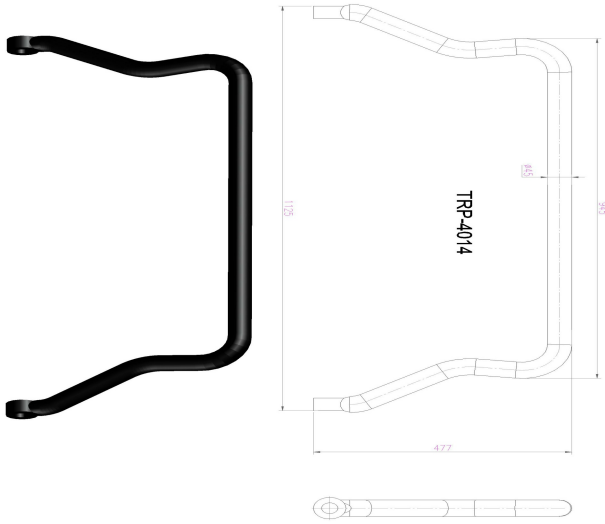

OEM REFERENCES		CROSS REFERENCES	
MERCEDES	6293230365		
MERCEDES	6293230665		
MERCEDES	6290030032		
MERCEDES	6290030232		
MERCEDES	6293230565		
MERCEDES	6293230465		

**TRP-4015**

**UNİMOG STABILIZATOR**



OEM REFERENCES		CROSS REFERENCES	

**TRP-4016**

**MAN REAR STABILIZATOR**



OEM REFERENCES		CROSS REFERENCES	

**TRP-4017** MERCEDES 0302 REAR STABILIZATOR



OEM REFERENCES		CROSS REFERENCES	

**TRP-4018** MERCEDES V6-V8 REAR STABILIZATOR



OEM REFERENCES		CROSS REFERENCES	

**TRP-4019** GÜLERYÜZ-COBRA REAR STABILIZATOR

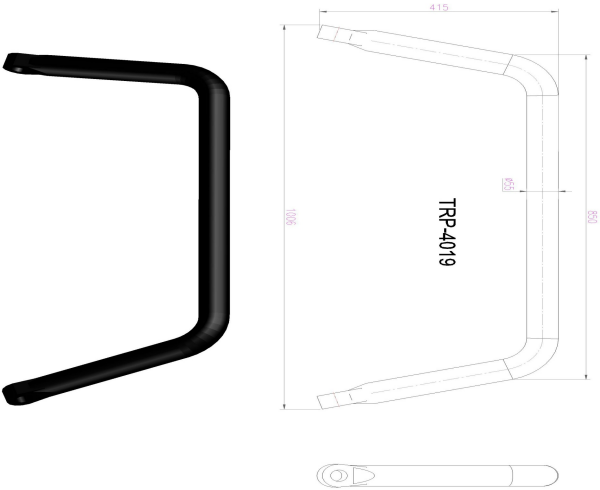

OEM REFERENCES		CROSS REFERENCES	



## TRP-4020

## SETRA 417 FRONT STABILIZATOR

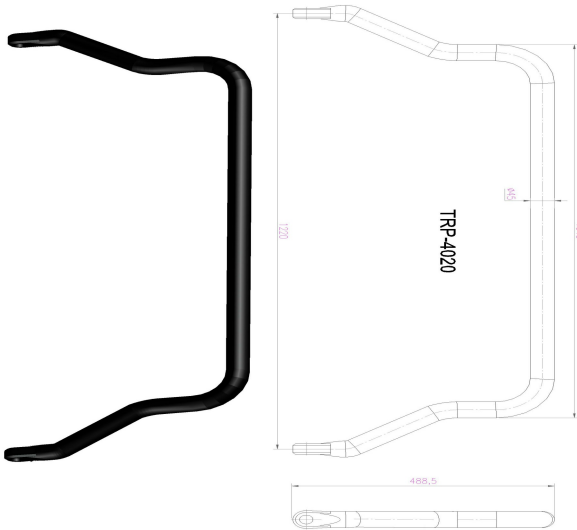

OEM REFERENCES		CROSS REFERENCES	
SETRA	139231111204C		

## TRP-4021

## SETRA 431 FRONT STABILIZATOR

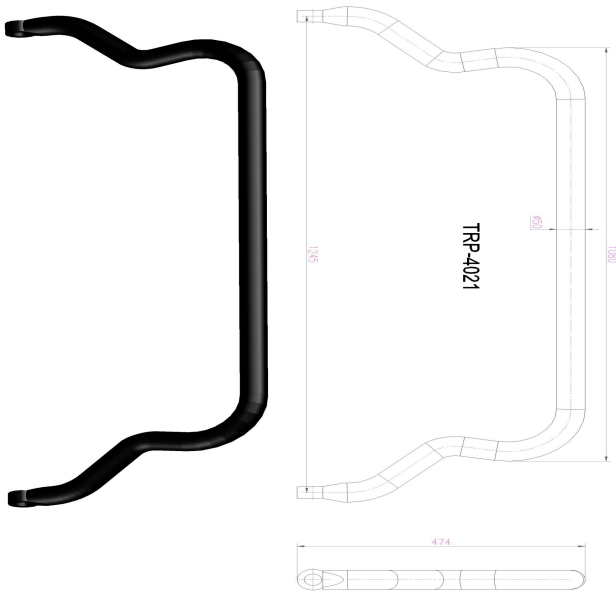

OEM REFERENCES		CROSS REFERENCES	
SETRA	4103230265		
SETRA	4103230565		

## TRP-4026

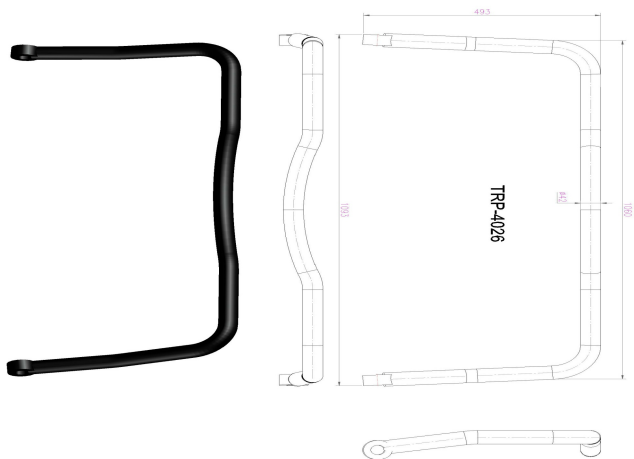

OEM REFERENCES		CROSS REFERENCES	
SETRA	179-23.11.111.02D		

**TRP-4027**

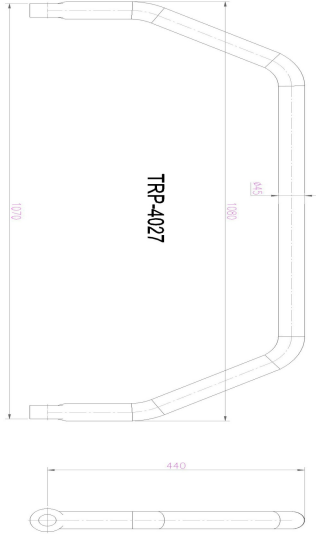

OEM REFERENCES		CROSS REFERENCES	